

SO4902M1N



Categorie	45 cm
Familie	Oven
Voeding	Elektrisch
Warmte bron	Elektrisch
Bereidingswijze	Combi-magnetron
Technologie	Micro combi
Reinigingsstelsel	Vapor Clean
EAN-code	8017709325701



Esthetiek

Esthetiek	Victoria	Deur	Met paneel
Kleur	Zwart	Handgreep	Victoria
Design	Bol	Kleur handgreep	Rvs look
Materiaal	Gelakt materiaal	Logo	Geassembleerd
Type glas	Clear1	Bedieningsknoppen	Victoria
Kleur serigrafie	Zwart	Kleur knoppen	Rvs look
Type zeefdruk	Symbolen		

Bediening

Naam display	EvoScreen	Regeling bediening	Bedieningsknoppen
Display technologie	LCD	Aantal bedieningsknoppen	2

Programma's / functies

Aantal kookfuncties 11

Traditionele kookfuncties



Statisch	Geventileerd	Circulaire
ECO	Grote vlak-grill	Base
Pizza		



Bereidingsfuncties met microgolven

 Magnetron  Geventileerd  Circulaire

 Microwave + grill

Overige functies

 Ontdooien op tijd  Rijsfunctie  Stone cooking

 BBQ  Air-Fry  Sabbath

Schoonmaak functie

 Vapor Clean

Opties



Opties	Automatische in- en uitschakeling	Overige opties	Warmhoudfunctie, ECO-Light, Helderheid, Tonen
tijdprogrammering		Showroom demo optie	Ja
Timer	Ja	Snelle voorverwarming	Ja
Timer	1		
Kinderbeveiliging	Ja		

Technische specificaties



Minimum temperatuur	30 °C	Deur	Temperatuur gecontroleerde deur
Maximum temperatuur	250 °C	Totaal aantal ruiten	3
Aantal kookniveaus	2	Automatische uitschakeling magnetron bij openen deur	Ja
Aantal lampen	2	Soft Close systeem	Ja
Soort verlichting	Halogeen	Soft open & close scharnieren	Ja
Vermogen lamp	40 W	Chimney	Fixed
Automatische inschakeling verlichting bij openen deur	Ja	Koelsysteem	Mantelkoeling
Onderwarmte - vermogen	1000 W	Koelleiding	Enkel
Grill - vermogen	2000 W	Afmetingen bruikbare interne ovenruimte (hxbxd)	211x462x401 mm
Circulatie - vermogen	1400 W	Temperatuurregeling	Elektronisch
Automatische uitschakeling verhittingselementen bij openen deur	Ja	Materiaal ovenruimte	Ever Clean emaille
Deur openen	Standaard opening	Veiligheidsscherm magnetrondeur	Ja

Prestaties / energielabel



Netto inhoud	40 l	Effectief magnetronvermogen	800 W
Aantal ovens	1		

Meegeleverde accessoires

Ovenrooster met stop	1	Glazen ovenplaat	1
Inzetrooster	1		

Elektrische aansluiting

Spanning	220-240 V	Frequentie	50 Hz
Nominale aansluitwaarde	3300 W	Lengte voedingskabel	150 cm

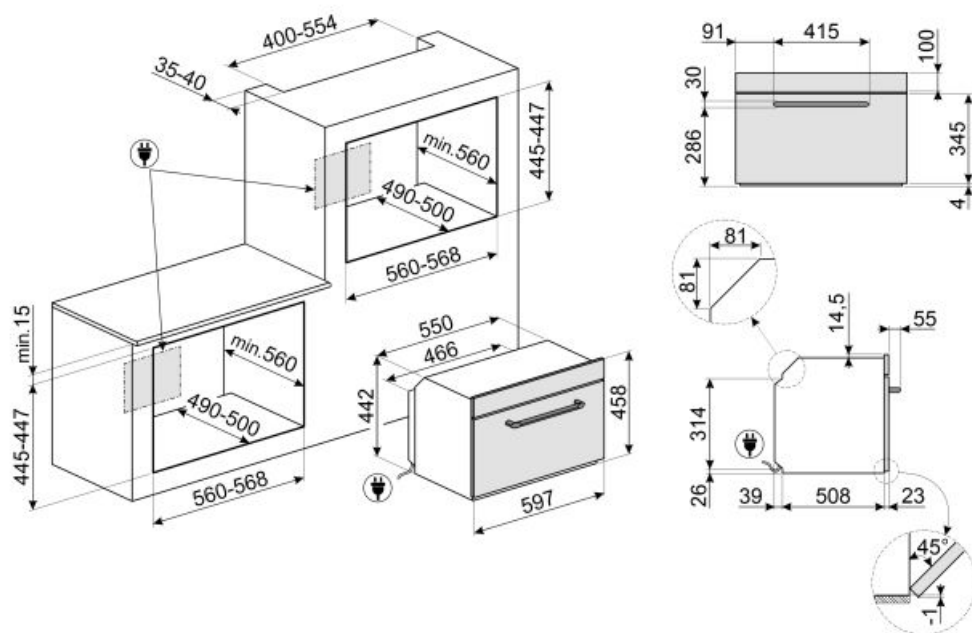

















Accessoires niet inbegrepen



















AIRFRY

Airfryerrek AIRFRY . Ideaal voor traditioneel frituren in de oven, maar met minder calorieën en minder vet. Hiermee creëer je snel en eenvoudig gerechten zoals frites, gebakken groenten en vis, waardoor ze perfect bruin en krokant worden.



Symbols glossary (TT)

 <p>Dedicated cooking function for the double sided plate BBQ. Suitable for recreating succulent and crispy dishes in the oven with the typical taste of grilled cooking. The ribbed side is particularly suitable for meats and cheeses; the smooth side for fish, seafood and vegetables.</p>	 <p>Kinderslot: sommige modellen zijn voorzien van een apparaat om het programma / de cyclus te vergrendelen zodat het niet kan per ongeluk veranderd</p>
 <p>Combination microwave: This oven allows to combine two different ways of cooking (Traditional with microwaves). Combined ovens increase cooking opportunities, while providing maximum flexibility of household appliances.</p>	 <p>Luchtkoelsysteem: om een veilig oppervlak te garanderen temperaturen.</p>
 <p>Ontdooien op tijd: met deze functie wordt automatisch het tijdstip van ontdooien van voedsel bepaald</p>	 <p>The new EVOscreen display is enhanced with new, optimised colour graphics: 5 touch buttons control functions and parameters in an extremely simple way.</p>
 <p>Deuren met driedubbele beglazing: aantal glazen deuren.</p>	 <p>Automatische verlichting gaat uit: voor meer energiebesparing schakelt de verlichting automatisch uit na één minuut na het begin van de bereiding.</p>
 <p>Electric</p>	 <p>Geëmailleerde binnenkant: De geëmailleerde binnenkant van alle Smeg-ovens heeft een speciale antacidumvoering die helpt om de binnenkant schoon te houden door de hoeveelheid kookvet te verminderen.</p>
 <p>Speciale kookfunctie voor het Airfryerrek AIRFRY. Ideaal voor het nabootsen van traditioneel frituren in de oven, maar met minder calorieën en minder vet. Hiermee kook je snel en eenvoudig gerechten zoals frites, gebakken groenten en vis, waardoor ze perfect bruin en krokant worden.</p>	 <p>Ventilator met bovenste en onderste elementen: de elementen in combinatie met de ventilator zijn bedoeld om een meer gelijkmatige warmte te bieden, een methode die vergelijkbaar is met conventioneel koken, dus voorverwarmen is vereist. Het meest geschikt voor items die langzaam koken vereisen.</p>
 <p>De ovenruimte wordt tegelijk door het onder- en bovenelement verwarmt. De hitteverdeling over het gerecht is afhankelijk van het niveau waarop men dit plaatst. Geschikt voor bakken op 1 niveau. Gerechten: alle ovenschotels, vlees, gevogelte, brood, (gevulde) taarten. Speciaal: gans en eend (bevatten veel vet).</p>	 <p>De ovenruimte wordt uitsluitend verhit door het onderelement. Voor gerechten die een hoge basistemperatuur behoeven, heeft deze bakstand weinig tot geen invloed op de korst aan de bovenzijde. Geschikt voor bakken op 1 niveau, ideaal voor deeggerechten die moeten rijzen (bijv. pizza). Bij gevulde taarten zal de deegbodem beter droog blijven.</p>
 <p>Circulaire: it is the perfect function for cooking all types of dishes in a more delicate way. The heat comes from the back of the oven and is distributed quickly and evenly The fan is active. It is also ideal for cooking on multiple levels without mixing smells and flavors.</p>	 <p>ECO: low energy consumption cooking: this function is particularly suitable for cooking on a single shelf with low energy consumption. It is recommended for all types of food except those that can generate a lot of moisture (for example vegetables). To achieve maximum energy savings and reduce time, it is recommended to put the food in the oven without preheating the cooking compartment</p>

- | | |
|--|---|
|  <p>De warmte wordt geproduceerd door het grill- en bovenelement. Verhitting over het volledige oppervlak. De thermostaat wordt, afhankelijk van het gerecht, in de regel op de maximale stand gezet. Bij een korte baktijd kan de ovendeur gesloten blijven; bij langere baktijd blijft deze gedeeltelijk geopend. Voor vleesgerechten (klein- en middelgroot), vleespennen, vis, groenten, gratineren etc.</p> |  <p>Microwave: Penetrating straight into the food, microwaves cook very quickly and with considerable energy savings. Suitable for cooking without fat, they are also able to thaw and heat food without altering its original appearance and aroma. The microwave function can also be combined with conventional functions with all the resulting advantages. Ideal for all types of food.</p> |
|  <p>Cooking with the simultaneous use of the heating element in combination with fan and microwave supply.</p> |  <p>Microwave + grill element: The use of the grill results in a perfect browning of the surface of the food. The action of microwaves allows instead of cooking in a short time the internal part of the food.</p> |
|  <p>Fan combined with traditional cooking, where heat is generated from above and below, provides uniform heat. Adding the microwave function allows the same cooking results in less time.</p> |  <p>Pizza function: Specific function for cooking pizza in a pan. It allows to obtain a pizza that is soft inside and crispy outside with the topping perfectly cooked, not dry and not burnt.</p> |
|  <p>Compact appliances with a height of 45 cm - perfect solution to meet the functional requirements of kitchen sets of small height. Available in several types and in different styles.</p> |  <p>KEEP_WARM_72dpi</p> |
|  <p>verlichting</p> |  <p>Air at 40°C provides the perfect environment for proving yeast type dough mixes. Simply select the function and place dough in the cavity for allotted</p> |
|  <p>Rapid preheating: cooking is preceded by the preheating phase which allows the cooking compartment to reach the set temperature. This option reduces the time by up to 50%.</p> |  <p>SABBATH: function that allows to cook food respecting Judaism's day of rest provisions.</p> |
|  <p>The oven cavity has 2 different cooking levels.</p> |  <p>Soft close: all models are equipped with advanced function of smooth closing of the door, which allows the device to close smoothly and quietly.</p> |
|  <p>Electronic control: Allows you to maintain temperature inside the oven with the precision 2-3 ° C. This enables to cook meals that are very sensitive to temperature changes, such as cakes, souffles, puddings.</p> |  <p>Tilting grill: the tilting grill can be easily unhooked to move the heating element and clean the roof of the appliance in one simple step.</p> |
|  <p>Vapor Clean: a simple cleaning function using steam to loosen deposits in the oven cavity.</p> |  <p>The capacity indicates the amount of usable space in the oven cavity in litres.</p> |
|  <p>Dedicated cooking function for the rectangular refractory stone PPR2 Dimensions Ideal for cooking pizzas with the same results as a typical wood-fired oven. Can also be used for baking bread, focaccias and other recipes such as pies, flans or biscuits</p> | |